



---

--



	IFSM			

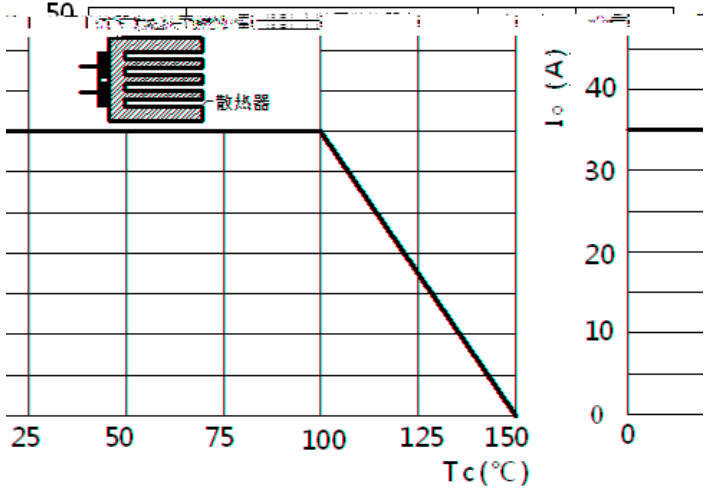

--	--	--	--	--

Derating Curve For Output Rectified Current

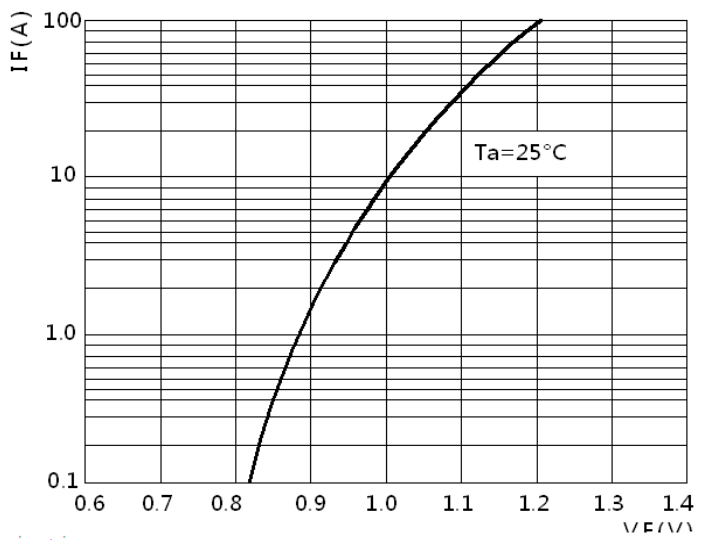
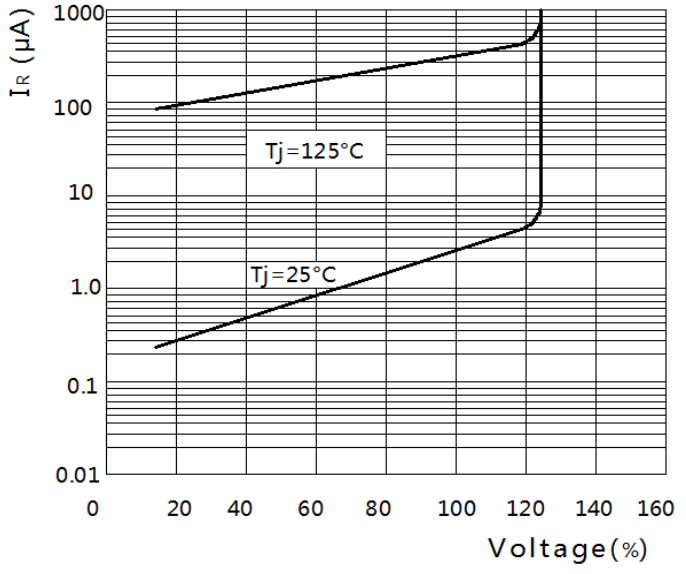
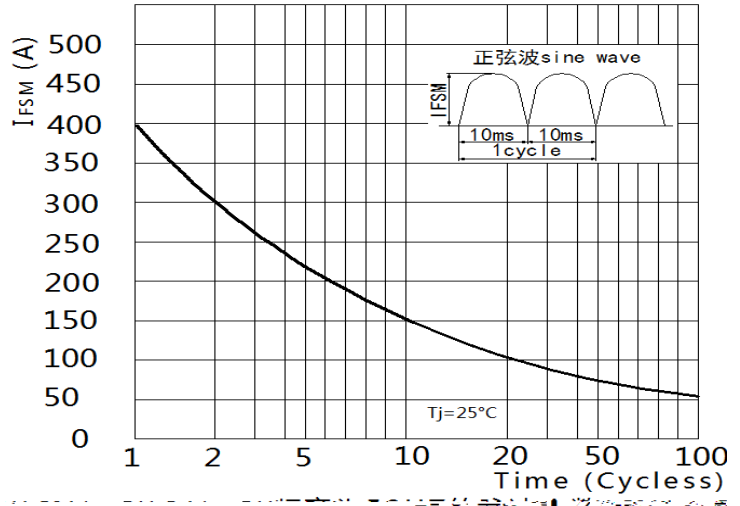

Maximum Non-Repetitive Peak Orward Surge Current Per Bridge Element

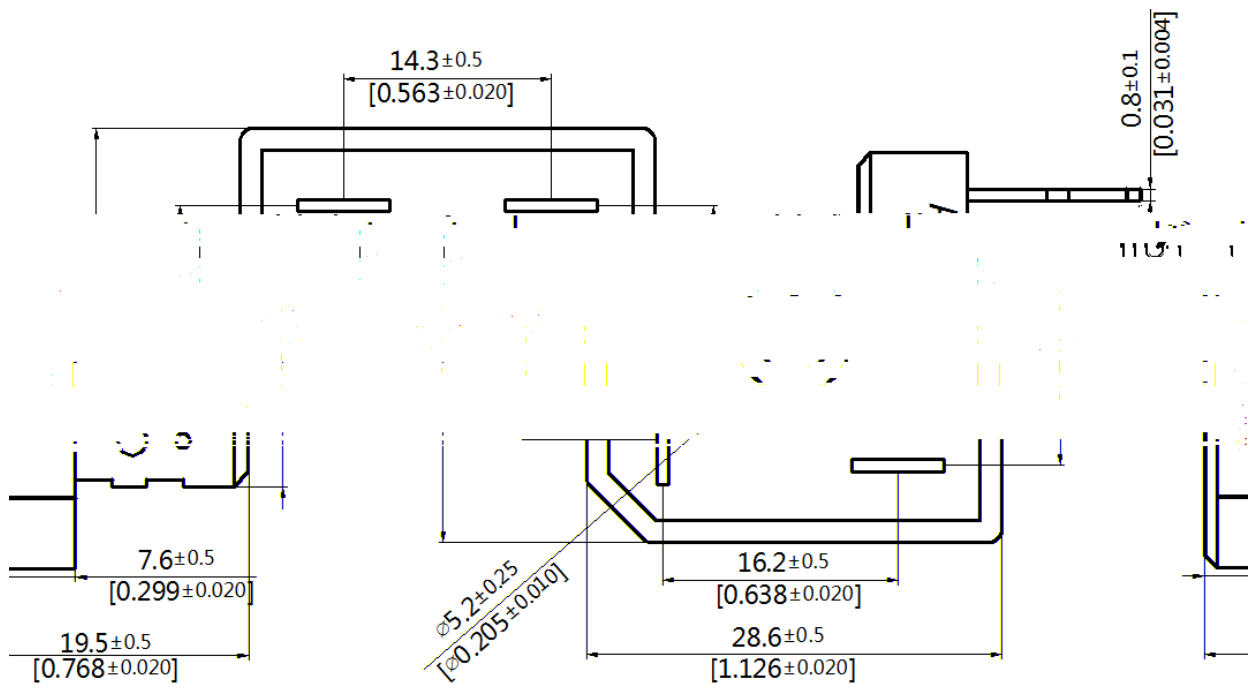



Dimensions in inches (mm)



+ 为正极标记

\*\* 为反向峰值电压 VRRM, 核算公式=数值\*10

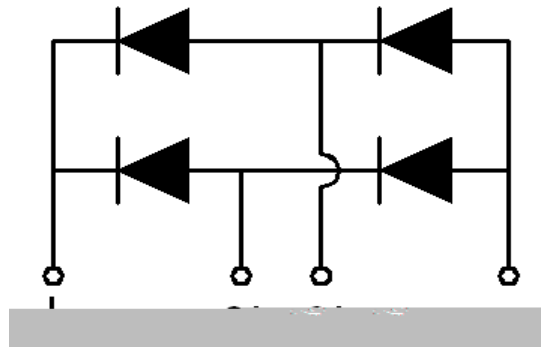
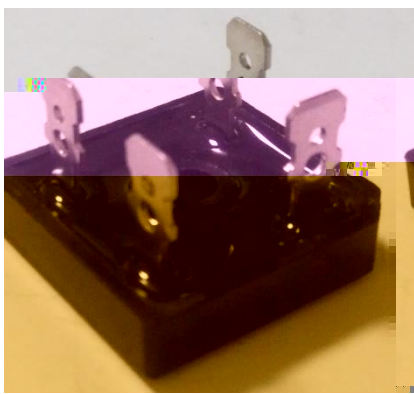



- 
- 
- 
- 
- 
  
- 
- 
- 
- 
  
- 
- 
  
- 
- 
- 
  
- 
  
- 
  
- 
-