

单相整流桥

特征



机械参数

产品适用范围



型号

()

()

特性曲线

Derating Curve For Output Rectified Current

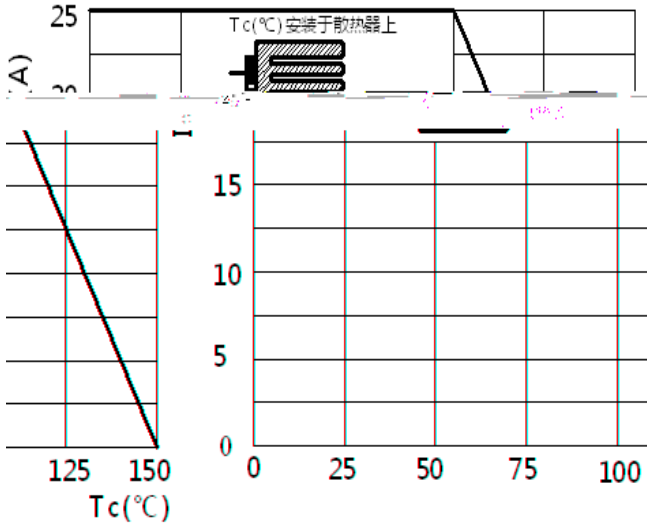

Maximum Non-Repetitive Peak Orward Surge Current Per Bridge Element

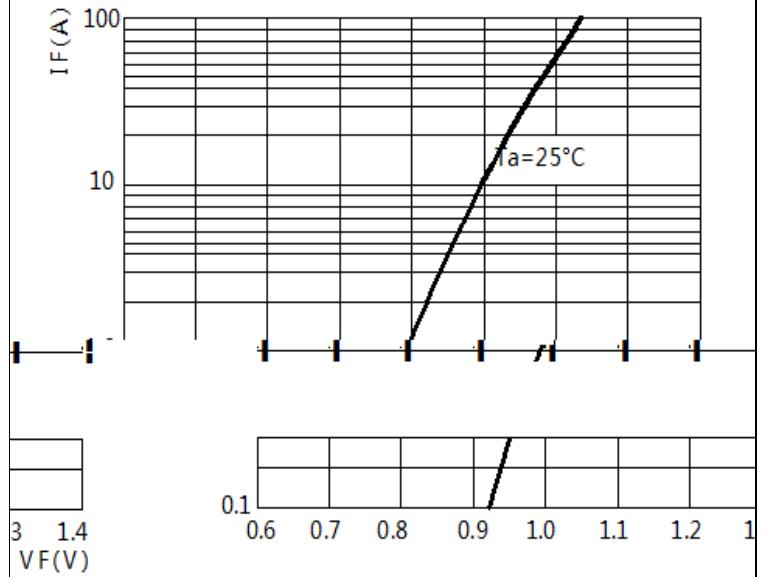
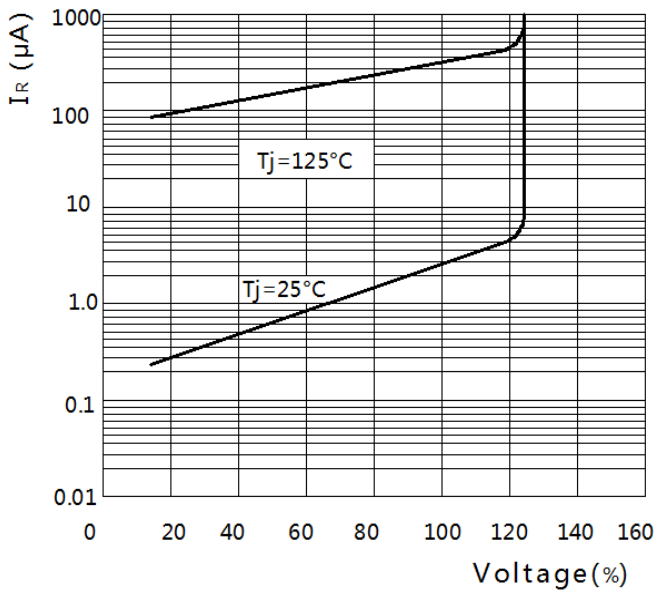
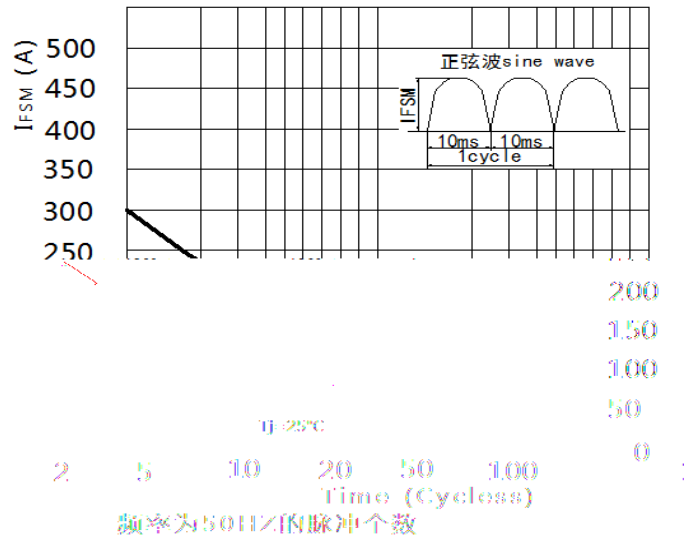

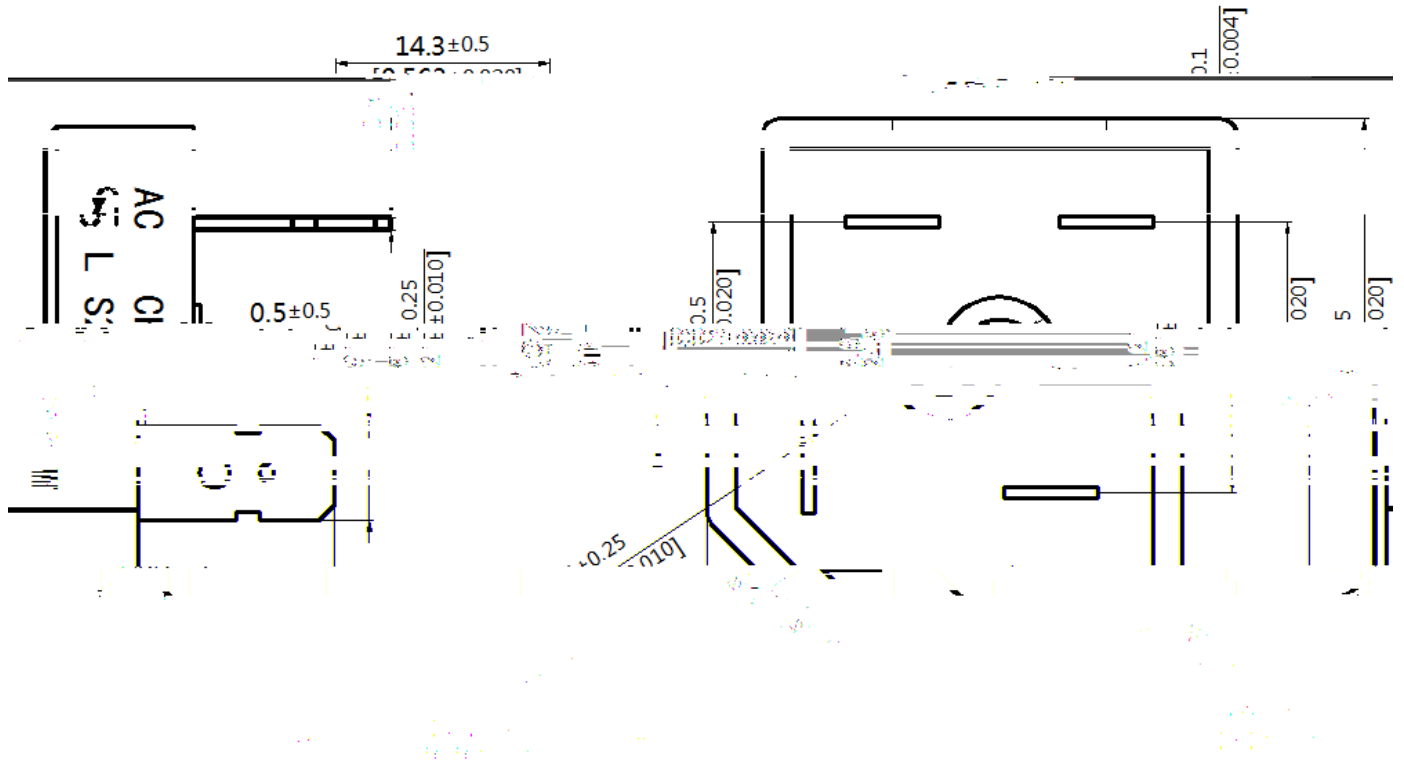

Dimensions in inches (mm)



+ 为正极标记

** 为反向峰值电压 VRRM, 核算公式=数值*10

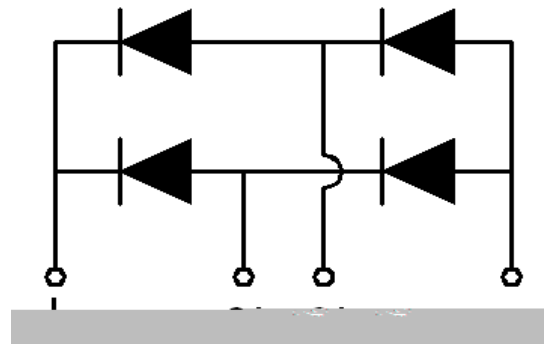
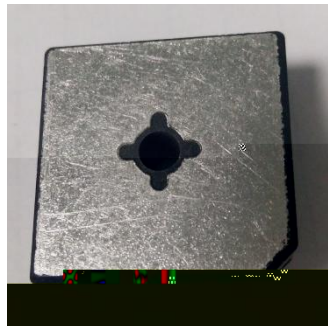

注意事项

-
-
-
-
-

-
-
-
-
-

-
-
-

-

-

-
-

-

包装和存储

-
-
-